

empowering
Nextlevel

ISO 9001 : 2008 Certified Company

 **milton**
ELEVATOR PVT. LTD.

Specialist in :-
Supply, Installation, Commissioning & Servicing Elevator & Escalator

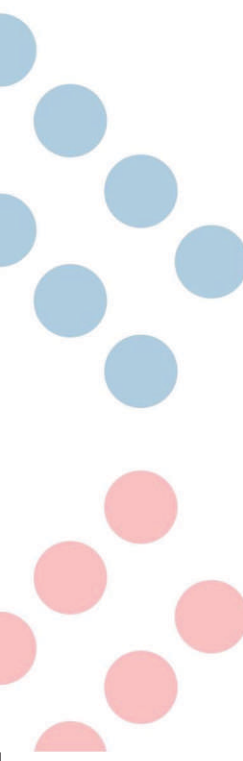





People in elevators travel comfortable through building and other urban space.

As buildings become larger and taller, MILTON strives to achieve ever-improving safety and energy savings.

We are a quality centric company and owing to several factors that benefit the customers and improve our performance magnificently, we are established as reliable and well-known name in this domain. The factors that counts are :

- Elevators designed as per the set industrial norms.
- Association with leading names.
- Stringent check on Procuring Process.
- Maximum customer satisfaction.
- Total quality management.
- Prompt Services.
- Experienced Workers.
- Efficient Workforce.
- Time Bound delivery.
- State-of-the-art-Warehouse.
- Well-organized Logistics facility.
- Transparent Business Deals.
- Good financial position.

We at MILTON offer following type of elevator



Traction Machine Room Elevator



Home Elevator



MRL Gearless Elevator



Hospital Elevator



Goods Elevator



Capsule Elevator



Parking Elevator



Hydraulic Elevator

Capsule Elevator

Capacity 10 to 16 Passenger



Squire Glass Cabin

Three Side Glass With MS Powder Coated Cabin

Three Side Square Glass Cabin

Stainless Steel Round Glass Cabin

Hoistway Elevation Drawing

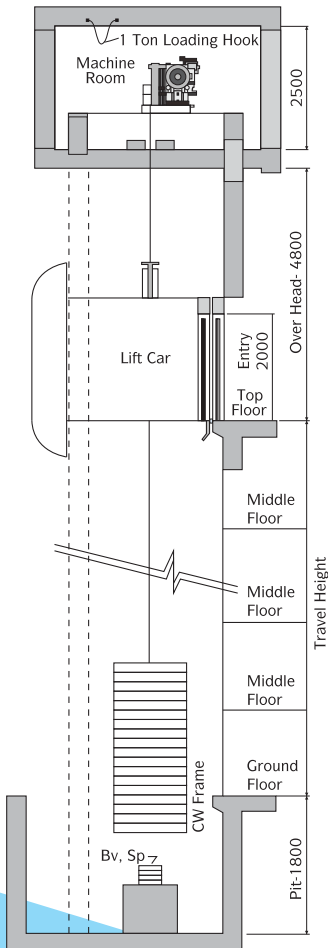

Hoistway Machine Room Plan For Capsule Elevator

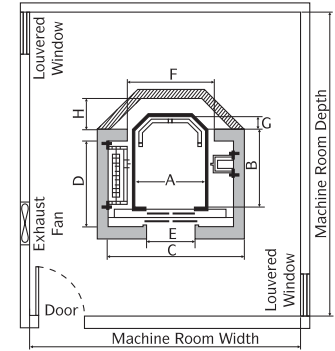
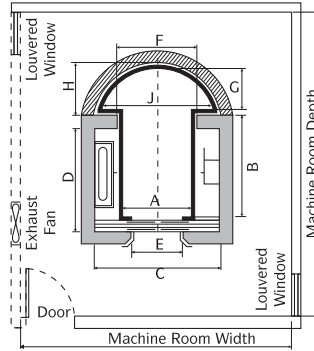

Planing Guide

Load		Car Inside			Shaft			Opening
Person	Kgs.	A	B	C	D	E	F	G
10	680	1100	1300	400	1900	1600	600	800
13	884	1200	1400	400	2000	1700	600	900
16	1088	1300	1500	500	2200	1800	750	1000

Load		Car Inside			Left Well			Entrance
Person	Kgs.	A	B	C	D	E	F	G
10	680	1100	1300	250	1900	1600	400	800
13	884	1200	1400	250	2000	1700	400	900
16	1088	1300	1500	300	2200	1800	500	1000

M/C Room
Pit 1500
O.H 4200

Manual Door

(Passenger Elevator)

Capacity 04 to 15 Passenger

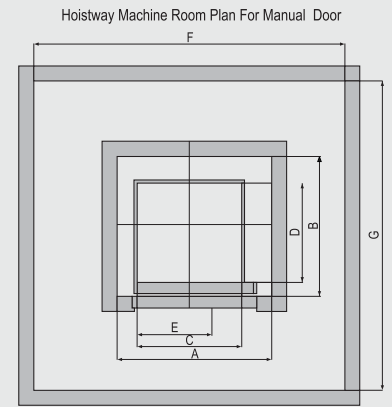

Hoistway Elevation Drawing

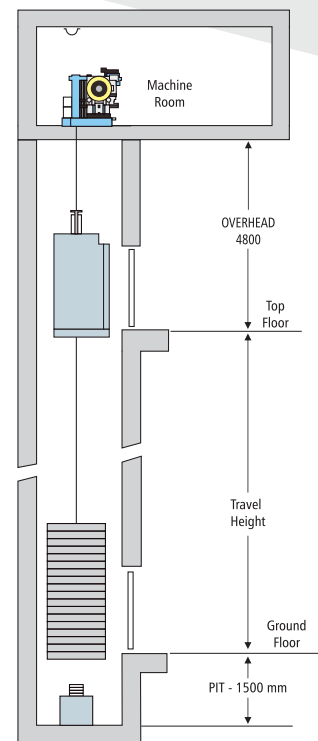

Hoist Way Machine Room Size Passenger Elevator with Manually Operated Doors

Load		Lift Well		Car Inside		Entrance	Machine Room			
Person	Weight	Width	Depth	Width	Depth		Width	Depth	Height	Pit
	IN KG.	A	B	C	D	E	F	G	H	
4	272	1400	1300	800	950	700	1400	1800	2200	1500
5	340	1500	1300	900	1000	700	1500	1800	2200	1500
6	408	1600	1500	1000	1100	700	1600	1800	2200	1500
7	476	1600	1600	1000	1200	700	1600	1800	2200	1500
8	544	1500	1700	1100	1300	800	1800	2000	2300	1500
9	612	1900	1700	1200	1300	800	1900	1900	2200	1500
10	680	1900	1900	1250	1300	800	1900	2100	2300	1500
13	884	1900	2400	1100	2000	800	1900	2800	2400	1500
15	1020	2000	2400	1200	2000	900	2000	2800	2400	1600
20	1360	2460	2650	1600	2300	1000	2460	2650	2400	1600

All Dimension are in mm.
 This is General Data, it may be changed without notice.
 All hoist way walls should be minimum 230 mm brick or 150 mm R. C. C.

Capacity 06 to 18 Passenger



MRL Elevator

Machine Roomless Elevator

Brings you a revolutionary concept in the field of elevators to give you absolute freedom in designing MRL -Machine Room Less Elevators! Our exclusive Machine room less elevators brings aesthetic enhancements for your structure.

Advantages

- Latest Technology in The World
- Smoothest Travel
- Absolute Freedom in Building Designs
- Substantial Saving On Electricity Cost
- Save The Construction Cost
- More Safe

Autodoor Door (Passenger Elevator)



Capacity 04 to 20 Passenger

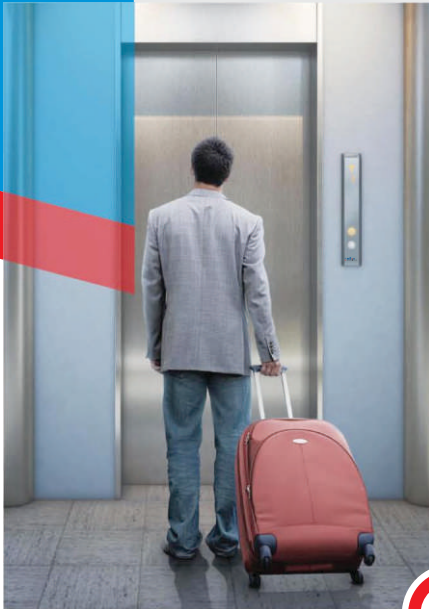

Hoistway Machine Room Plan For Auto Door

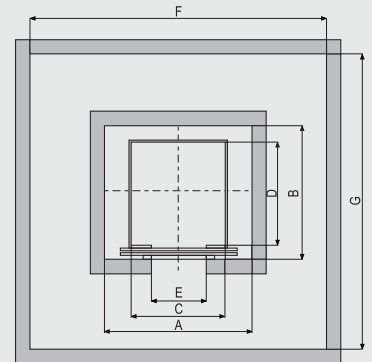

Hoistway Elevation Drawing

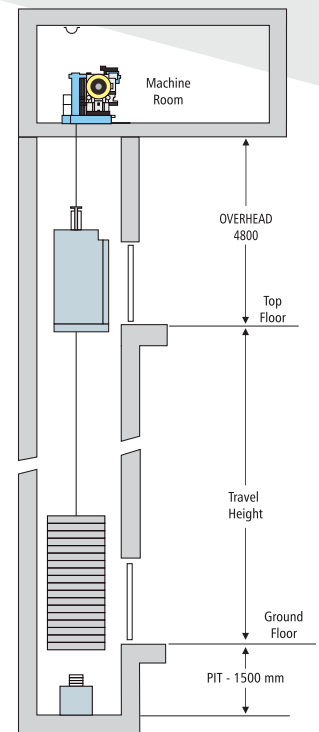

Hoist Way Machine Room Size Passenger Lift With Auto Doors

Load		Lift Well		Car Inside		Entrance	Auto Door (MRL)	
Person	Weight	Width	Depth	Width	Depth	E	Pit	O.H.
	IN KG.	A	B	C	D			
4	272	1400	1300	800	950	700	1500	4300
5	340	1500	1300	900	1000	700	1500	4300
6	408	1600	1500	1000	1100	700	1500	4400
7	476	1600	1600	1000	1200	700	1500	4400
8	544	1800	1700	1100	1300	800	1500	4400
9	612	1900	1700	1200	1300	800	1500	4400
10	680	1900	1900	1250	1300	800	1500	4500
13	884	1900	2400	1100	2000	800	1500	4600
15	1020	2000	2400	1200	2000	900	1600	4800
20	1360	2500	2800	1600	2300	1000	1600	4800

All Dimension are in mm.
This is General Data, it may be changed without notice.
All hoist way walls should be minimum 230 mm brick or 150 mm R. C. C.

Energy Saving

1600
Energy saving gearless
permanent magnet synchronous
traction machine.

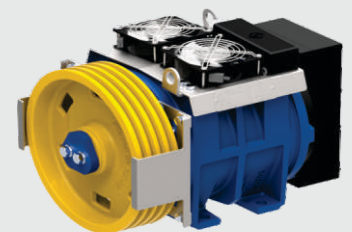
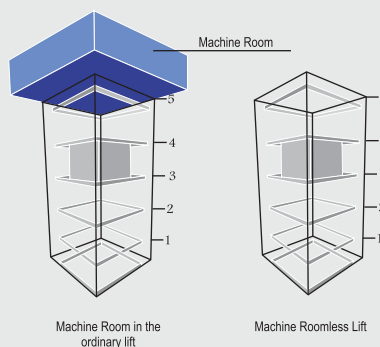

MRL Gearless Machine

Simple Think's
You Can Do
To Save Time with
MRL Lift

Hospital Elevator

Capacity 15 to 26 Passenger

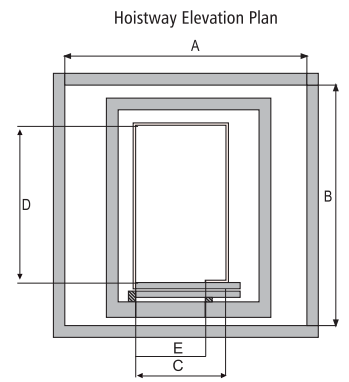

Hoistway Elevation Drawing

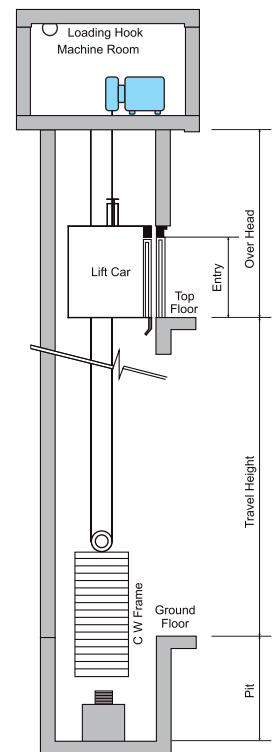

Hoist Way Machine Room Size Hospital Elevator

Automatic Center Opening Door

Automatic Telescopic Door

LOAD IN KG	LIFT WELL		CAR INSIDE		ENTRANCE E	SHAFT		CAR	
	WIDTH A	DEPTH B	WIDTH C	DEPTH D		WIDTH F	DEPTH G	PIT	O.H.
884	1800	2400	1100	2000	800	1800	2400	1100	2000
1020	1900	2800	1150	2400	900	1900	2800	1150	2400
1360	2000	2800	1200	2400	1000	2000	2800	1200	2400
1768	2400	3000	1500	2400	1000	2400	3000	1500	2400

All Dimension are in mm. This is General Data, it may be changed without notice.

Car Stacker Parking



Automobile Elevator



500 to 3000 Kg. Load Capacity

Goods Elevator

500 to 5000 Kgs Load Capacity

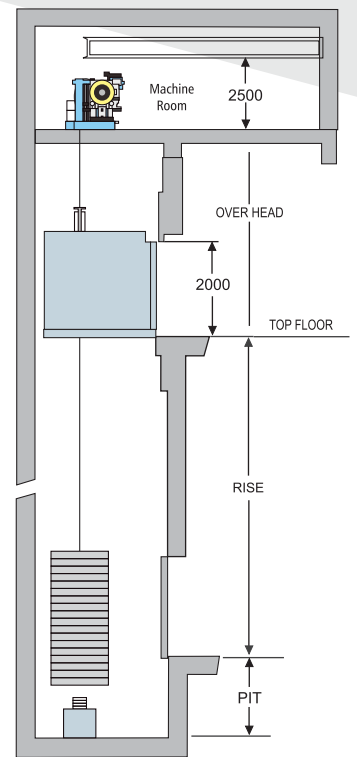
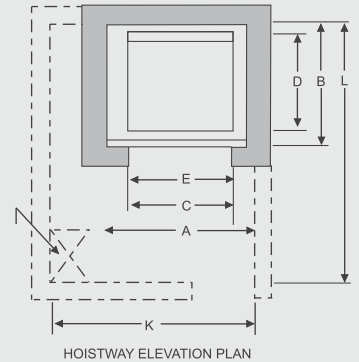

STURDY AND DURABLE :

Cabin is made of highly intensified shaped materials, able to carry various kind of cargo.

ACCURATE LEVELING :

The Accuracy of Leveling can be controlled with in a scope of several millimeter.

LARGE DOOR WIDTH :

Multiple folded cabindoor structure is employed to reach the max width which facilitate the Entry of Large cargo.

LOAD	LIFT WELL		CAR INSIDE		ENTRANCE	MACHINE ROOM			
WEIGHT IN KG	WIDTH A	DEPTH B	WIDTH C	DEPTH D	E	WIDTH F	DEPTH G	PIT	O.H.
500	1600	1500	1100	1200	1000	1600	1800	1500	4000
750	1600	1700	1100	1350	1000	1600	1800	1500	4000
100	2100	2100	1400	800	1200	2100	2500	1500	4000
1500	2500	2300	1700	2000	1500	2500	2500	1500	4000
2000	2700	2600	1900	2300	1800	2700	2600	1500	4200
2500	3100	3000	2000	2400	2000	3100	3000	1600	4200
3000	3400	3000	2100	2400	2250	3400	3000	1600	4500

All Dimension are in mm. This is General Data, without notice.

Technical Data :

Description	Vertical Transportation for Cars/ LMVs
Segment	Industrial applications & Car Parks
Max. travel (m)	100 (Solutions available for higher travel)
Max. load (kg)	500 - 3000 Kg (Solutions available for higher capacities)
Max. speed (m/s)	0.5 mps (Solutions available for other speeds)
Max. group size	Duplex



Drum Type Machine

Flooring



Aluminum Chequered Plate

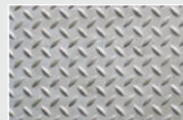

M.S. Chequered Plate

Rope



Usha Martin

Fan



Round Fan

Home Elevator



Change Your Lifestyle with Best Home Lift



Capacity 03 to 04 Passenger



Save Energy



Low Noise



Comfortable

Mini Single Phase Gearless Machine Home Lift



Low Noise



No Machine Room



Compact Designs



Gearless



Blower Fan

Up to **30%** Power saving

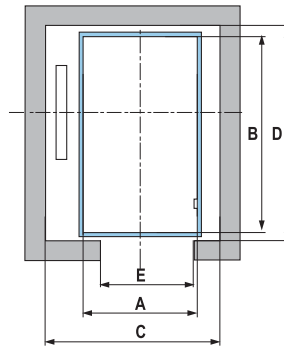

HOISTWAY ELEVATION PLAN

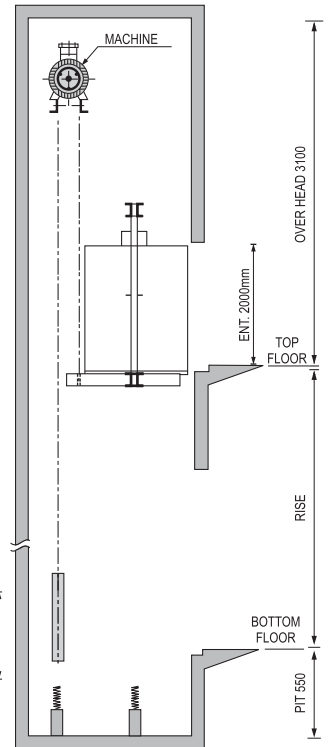

Dimensions Table

Door Operation	Load		Lift Well		Car Inside		Entrance E	Speed (MPS)	Pit	Over Head
	Persons	KGS	C	D	A	B				
Manual Door	3	204	1100	1200	810	700	700	0.3	550	3100
Manual Door	4	272	1300	1400	800	1200	700	0.3	550	3100
Auto Door	3	204	1250	1250	810	700	700	0.3	550	3100
Auto Door	4	272	1300	1600	850	1150	700	0.3	550	3100

Note : This Is Our Standard Data, If other Special Requirement Please Contact us.

Elevator Control Panel



VVF Drive



Arkel



Integrated Lift Controller



Hydraulic Lift Controller



MRL Integrated Controller

Hydraulic Elevator

Capacity 03 to 24 Passenger

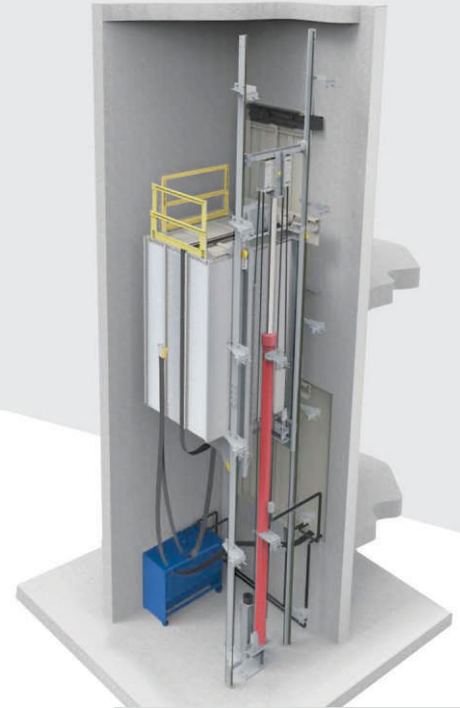
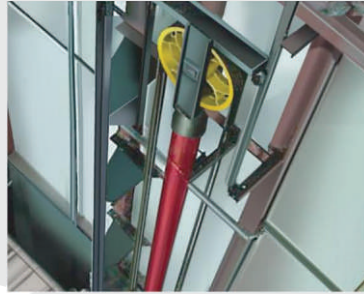

HOLE TYPE

It is a directly suspension with a simple or split piston.
It is the simplest solution of suspension for any load. upto 6 meters travel.

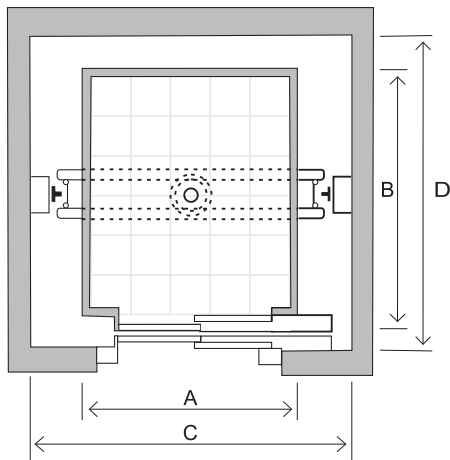

LOAD	LIFT WELL		CAR INSIDE		ENTRANCE	O/H	ENTRANCE TELESCOIP	CENTRE OPENING
WEIGHT IN KG	WIDTH A	DEPTH B	WIDTH C	DEPTH D	PIT E			
204	1400	1200	11100	600	300	3300	700	
272	1400	1300	1100	700	300	3300	700	
340	1500	1350	1200	750	300	3300		700
408	1500	1500	1200	900	300	3500		700
544	1500	1800	1200	1200	300	3500		700
680	1800	1800	1400	1200	500	3800		800
884	1800	2100	1400	1400	500	3800		800
1088	2000	2400	1500	1600	800	4000		900

All Dimension are in mm. This is General Data, without notice.

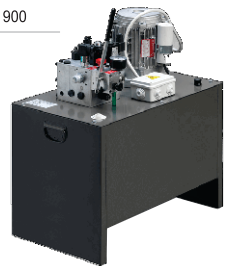

Omar Hydraulic Power Pack

Geared Traction Machine



Sharp



Heena



Montanari

Gearless Traction Machine



Sharp



Mona Drive



Montanari

Doors

Manual Door

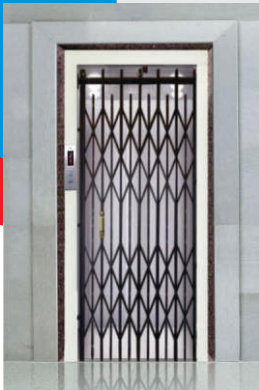

Collapsible Door



Imperforated Door

A wide Choice of Durable Interior Materials



M.S. Two Fold Telescopic Door



M.S. Swing Door

Automatic Door



Center Opening Auto Door (Small Vision)



Plain S.S Auto Door



Center Opening Glass Auto Door



Center Opening Auto Door (Four Panel)

COP & LOP



KCG 251



KXG 251



KCG 351



KXG351

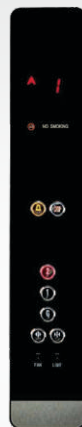

BCG 311



BXG 311



Segment Type LED Position / Direction Indicator



Horizontal Display Effect



M.S Cabins



MEPL 01



MEPL 02



MEPL 03



MEPL 04



MEPL 05



MEPL 06

Designer Silver Cabins

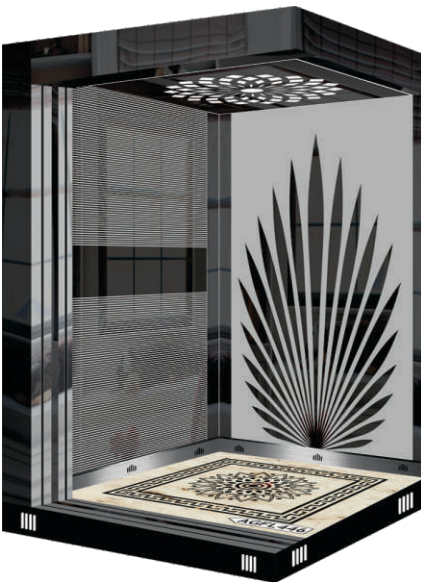
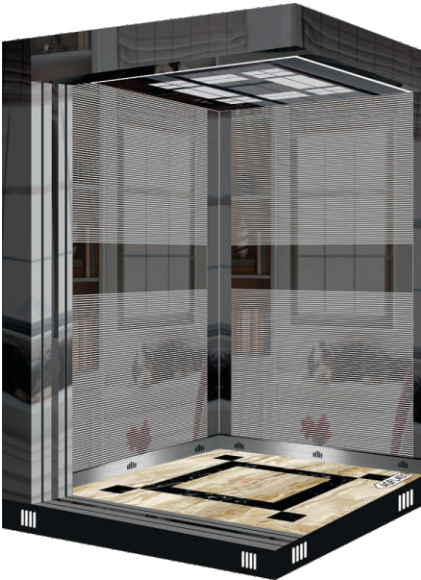

Designer Gold Cabins



MEPL 07



MEPL 08



MEPL 09



MEPL 09

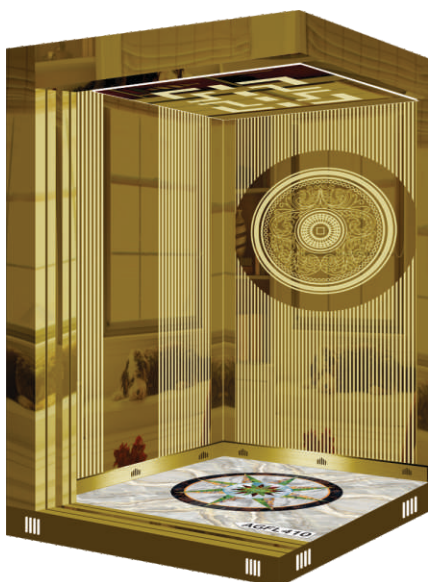

MEPL 11



MEPL 12

Designer Rose Gold Cabins



MEPL 13



MEPL 14



MEPL 15



MEPL 16



MEPL 17

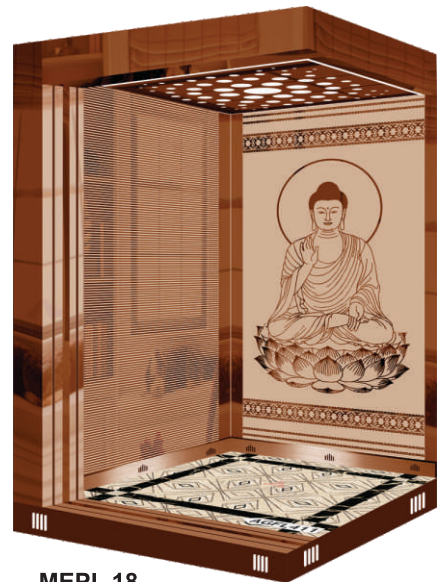

MEPL 18

ISO 9001 : 2008 Certified Company

We are
Technically
Associated
with



MONTEFERRO



Aonarch®
Elevator control expert Step with the world



ARKEL

TORINDRIVE

Bharat Bijlee

IBST
We pursue the best!

Fermator
AUTOMATIC DOOR FOR LIFTS

philbrick®
PROVIDING ELEVATOR SOLUTIONS

usha martin



Plot No - 73, Patparganj
Industrial Area, Delhi-110092

Land Line.: 011 - 35008322 / 23
Mob .: +91 - 8683000611 / 12
Toll Free .: 1800- 890- 6450

E-mail : sales@miltonelevator.com
Website : www.miltonelevator.com

Specialist in :-
Supply, Installation,
Commissioning &
Servicing Elevator
& Escalator

Factory

Milton Elevator Pvt. Ltd.
Plot No - 2164, Rai Industrial Area,
Sonapat, Haryana - 131029

Branches

Haryana

Milton Elevator Pvt. Ltd.
Golden Garden Building, 2nd Floor,
Near Malik Hospital, Gohana Road,
Panipat, Haryana - 132103

Punjab

Milton Elevator Pvt. Ltd.
198 Aggar Nagar, Enclave
Ludhiana, Punjab - 141012

Uttarakhand

Milton Elevator Pvt. Ltd.
Vasu Estate - 39/10A
Lane No. - 1, Canal Road, Jakhan
Dehradun - 248001

Uttar Pradesh

Milton Elevator Pvt. Ltd.
Plot No- 1213, Sector - 05,
Vasundhra Ghaziabad
Uttar Pradesh - 201012